

POWERSTAR Skip Loader Truck

User's Manual



POWERSTAR TRUCKS INDUSTRY CO., LIMITED

<http://www.isuzutruckscn.com/>



ISUZU HIGH-PERFORMANCE SKIP REFUSE TRUCK

POWERSTAR

OWNER'S MANUAL

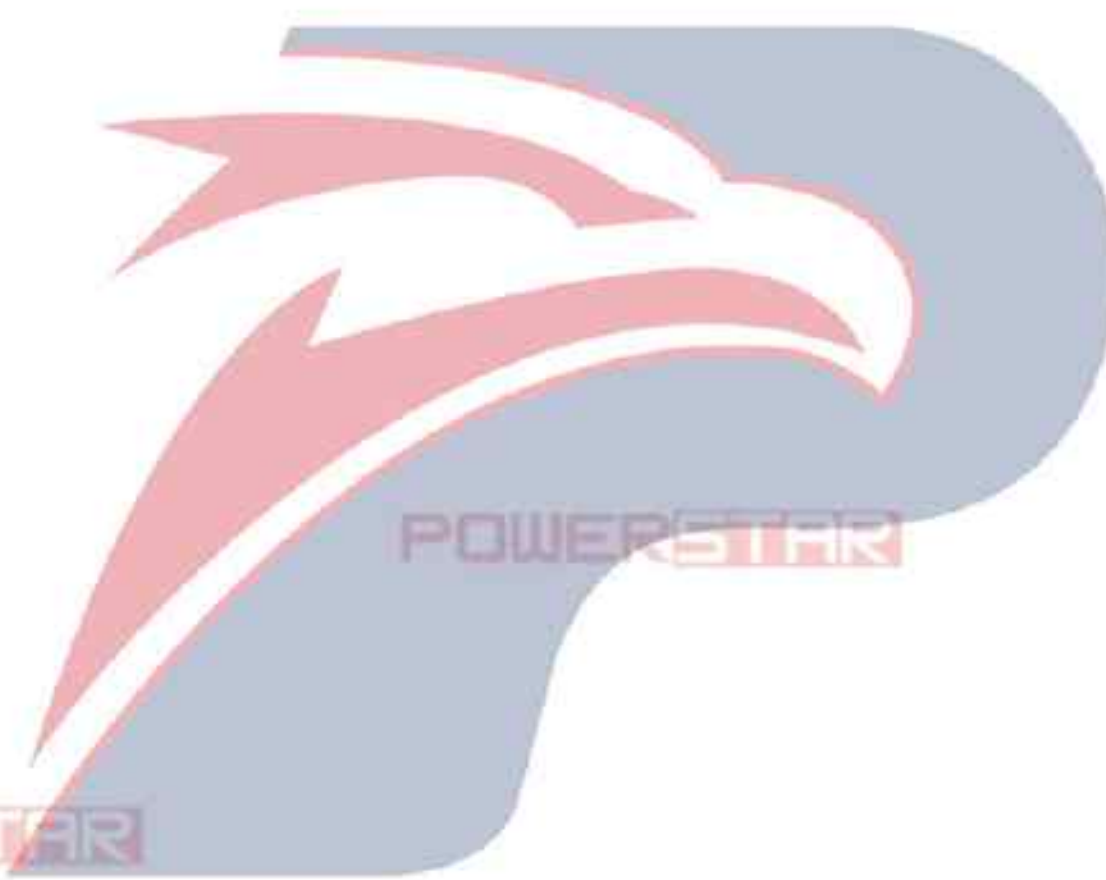

POWERSTAR

Preface

Thank you for purchasing POWERSTAR TRUCKS products. For better using your ISUZU Skip Refuse Truck, get the best operating performance, we strongly suggest that before the operation process you should read this manual instructions carefully, and to manipulate the program handily.

The manual detailed describes the performance of skip refuse truck, structure, usage, precautions and maintenance of such knowledge. While showing details of the truck, both pictures and description will together help you get better understanding of how to use truck. Before the operation, the skilled operator should carefully read the contents of the manual.

After master the truck performance characteristics, methods of operation and precautions, then could start to operate this garbage truck. In order to ensure the staff turnover after the operation, and properly use of the truck. This manual book must be properly kept, shall not be lost and damage.

----POWERSTAR TRUCKS



POWERSTAR

Contents

Chapter 1. General Description	5
Chapter 2, Main Technical Data.....	6
Chapter 3, What is Skip Refuse Truck	7
i , Skip Refuse Truck Advanced Feature.....	7
ii , Skip Refuse Truck Working Principle.....	8
Chapter 4, How to Operate Skip Refuse Truck	10
i ,Skip Refuse Truck Introduction.....	10
ii ,Skip Refuse Truck Operation Guidance (Very Important)	12
Chapter 5, Others for Attention.....	14
Chapter 6 Troubleshooting	15

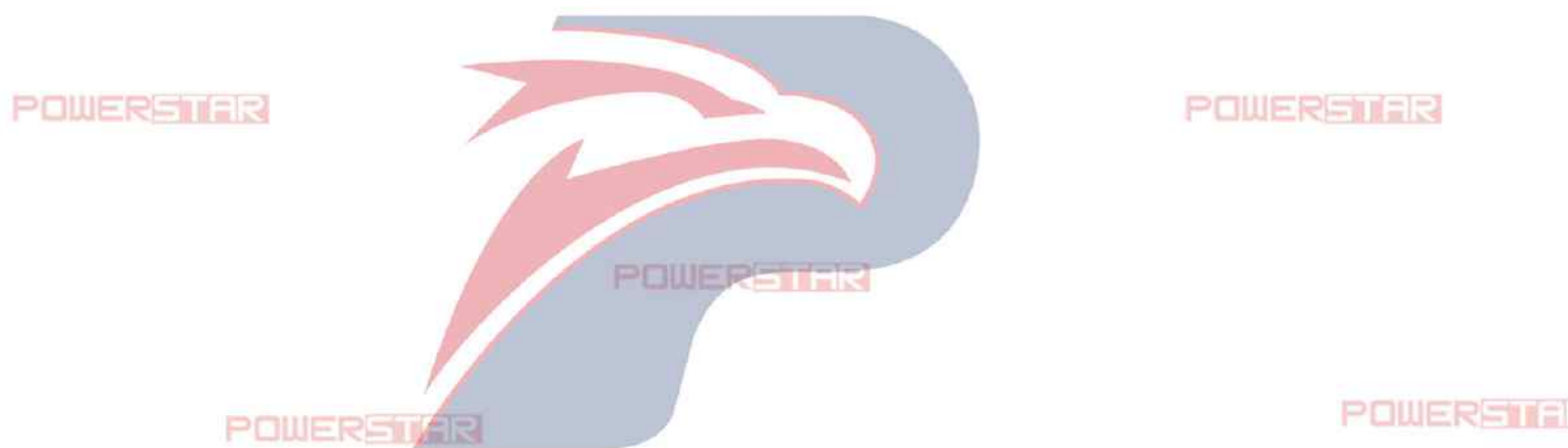

POWERSTAR

Chapter 1. General Description

*POWERSTAR TRUCKS Skip Refuse Truck based on type II ISUZU 4*2 LHD chassis, refuse container capacity could up to 6,000liters, mainly used for garbage collection, storage and transportation, and the working aerial can be city street, factory, community and other areas of need.*

*The vehicle designed to fully rely on the advantages of the original 4*2 left-hand-drive chassis, fully consider the product's convenience, reliability and features. The swing arm and rubbish container material is international standard steel, all with anti-rust painting, which can effective to avoid rusting. As for rubbish container capacity, this can be up to 6CBM and very big enough to meet customers' garbage transport requirement.*

*The ISUZU 4*2 Skip Refuse Truck equipped with Swing Arm and two hydraulic legs, which can be used carrying 6CBM garbage container. For one skip garbage truck, can be match used with several containers. And the garbage containers can be spread everywhere for rubbish collection. Therefore, the vehicle is an ideal Skip Refuse Truck mainly for refuse collection & refuses transportation.*



(Preview for your ISUZU Skip Refuse Truck)

Chapter 2, Main Technical Data

Basic parameter:

Items		6CBM ISUZU Skip Refuse Truck
S I Z E	Outer Dimension (L×W×H) (mm)	6000*2000*2680
	Wheelbase (mm)	3360
Kerb Weight (kg)		4200
G E A R	Gearbox brand	ISUZU MSB
	Model	5-shift gearbox
	Type	Manual
Cab capacity (includes driver)		2
E N G I N	Model	ISUZU 4JB1CN
	Type	Four cylinder inline, water-cool, turbocharged Inter-cooling, diesel
	Rating Power (kW/HP)	72/98
	Emission Standard	Euro 4

Note: 1.The vehicle height includes Swing Arm.

2. We keep the right to revise the parameters on the list above.

Skip Refuse System basic parameter list

Items		Parameter	
Control System		Hydraulic control system	
Swing Arm		High Strength steel material	
Hydraulic Legs		Double hydraulic legs at rear for support	
G a r b a g e C o n t a i n e r	Capacity (CBM)	6	
	Material	Standard Carbon Steel	
	Painting	Internal	With anti-rust painting
		External	White painting with Logos
	Dimensio n	Length (mm)	3100
		Width (mm)	1410
Height (mm)		1500	

Chapter 3, What is Skip Refuse Truck

1. Skip Refuse Truck Advanced Feature

POWERSTAR TRUCKS produce Skip refuse truck also named skip loader truck, swing arm garbage truck. This based on famous ISUZU brand truck chassis, refitted with special upper structure. As for the component, including Swing Arm System, Hydraulic System, Control System, Container, etc. Technical drawing with dimension as following:

Swing Arm System: The material for swing arm is high strength steel, which was welded based on chassis dimension. Operating the Multi-way Valve can control hydraulic cylinder to move, which can control the swing arm rotating, the maximum swing angle can be up to 145° . The Swing Arm System can be used loading & unloading container.

Hydraulic System: The skip refuse truck totally controlled by hydraulic system, including swing arm rotating, hydraulic legs stretch out and draw back.

Operation System: Control PTO to transit power to oil pump work, then operating the multi-way control valve joysticks to make swing arm and hydraulic legs working, and can control the garbage container loading and unloading.

Container: The material is high strength steel, and model is standard type with no cover. When bulk rubbish throws into the container, hang up the sling chain to container, then operating multi-way control valve to load and unload container. For one truck can match with tens of container at one time. Detail construction for one container as follow:

POWERSTAR

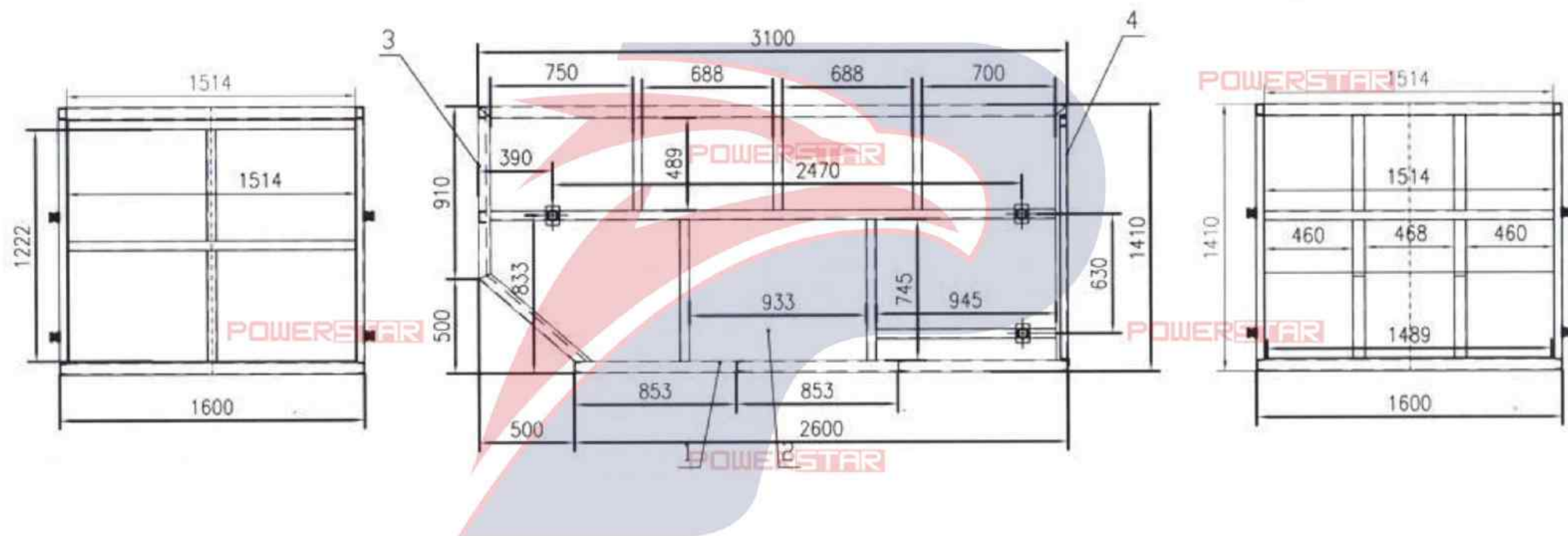

Items	Name	Quantity
1	Side Plate Assembly	2
2	Bottom Plate Assemble	1
3	Rear Door Assembly	1
4	Front Plate	2
5	Front Plate Channel Plate	4
6	Rear Door Hook	2

ii , Skip Refuse Truck Working Principle

As for hydraulic control system, which including oil tanker, oil pump, multi-way control valve, hydraulic cylinder, balancing valve, hydraulic leg lock, oil filter, pipeline system, etc.

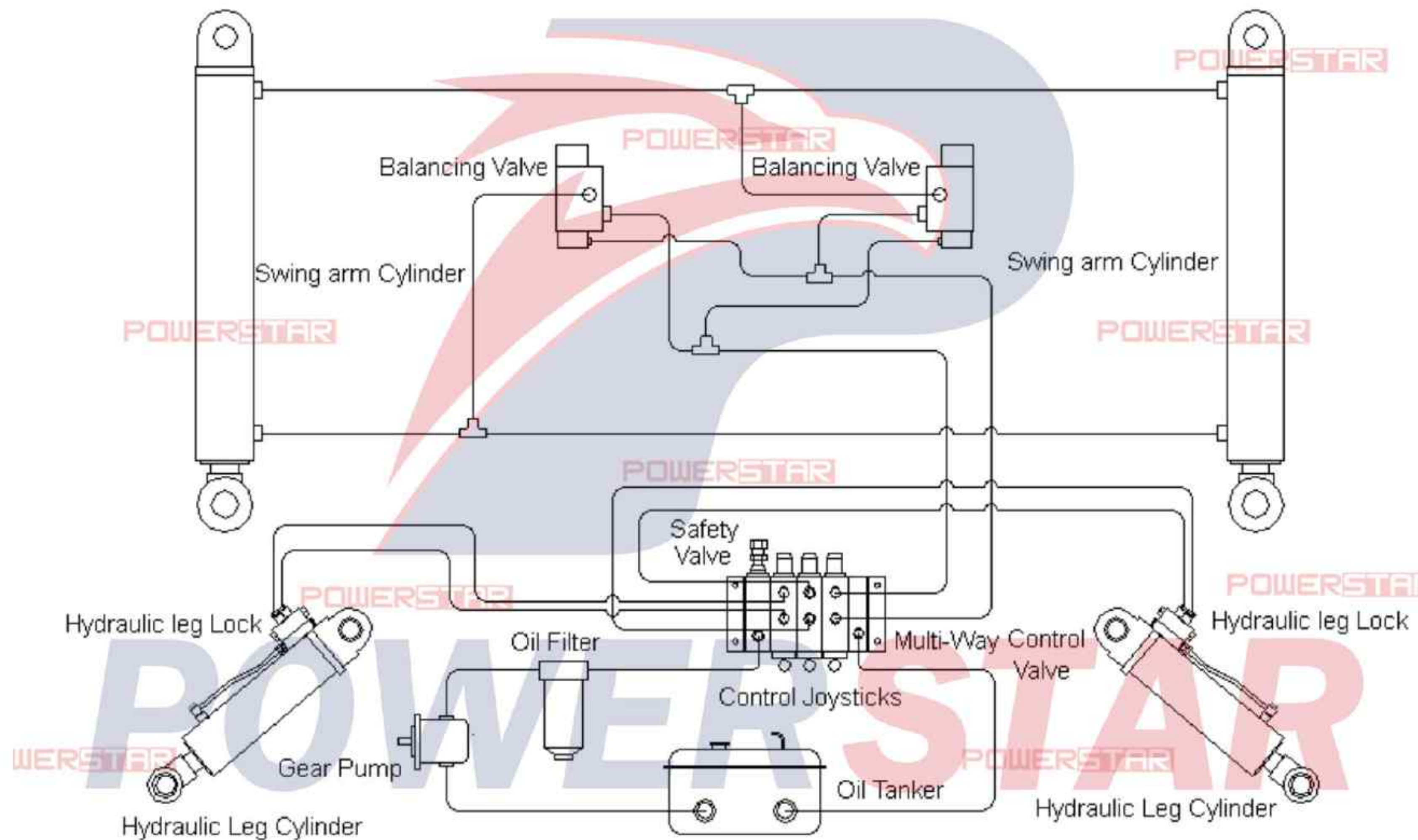

The PTO (Power Take Off) gets power from Truck Engine, then transit power to Oil Pump through transmission shaft, the Oil Pump start working, Multi-way Control Valve can control the swing arm and hydraulic legs working, which can match with refuse container loading and un-loading, then realize the garbage collection and transportation job.

The Hydraulic system equipped with Balancing Valve & Hydraulic Lock. To be more specific, Balancing Valve ensures the swing arm working more smoothly and safety, which can efficiently prevent garbage container loading and unloading too fast or too slow. Hydraulic Lock can protect the hydraulic legs during working.

When not operating Multi-way Control Valve and Control Joysticks, the hydraulic oil will flow back to oil tank through Multi-way Control Valve.

The Maximum working pressure for Hydraulic System is 16MPa, this pressure is limited by safety valve on Multi-Way Control Valve. Frankly speaking, when hydraulic system working pressure over 16MPa, the hydraulic oil will through safety valve back to oil tank, means the truck is over loading, the hydraulic system cannot working properly.

Please note that the Safety Valve has been set in factory, do not adjust anything!

Chapter 4, How to Operate Skip Refuse Truck

1. Skip Refuse Truck Introduction

Overview for ISUZU 6 CBM skip refuse truck technical drawing:

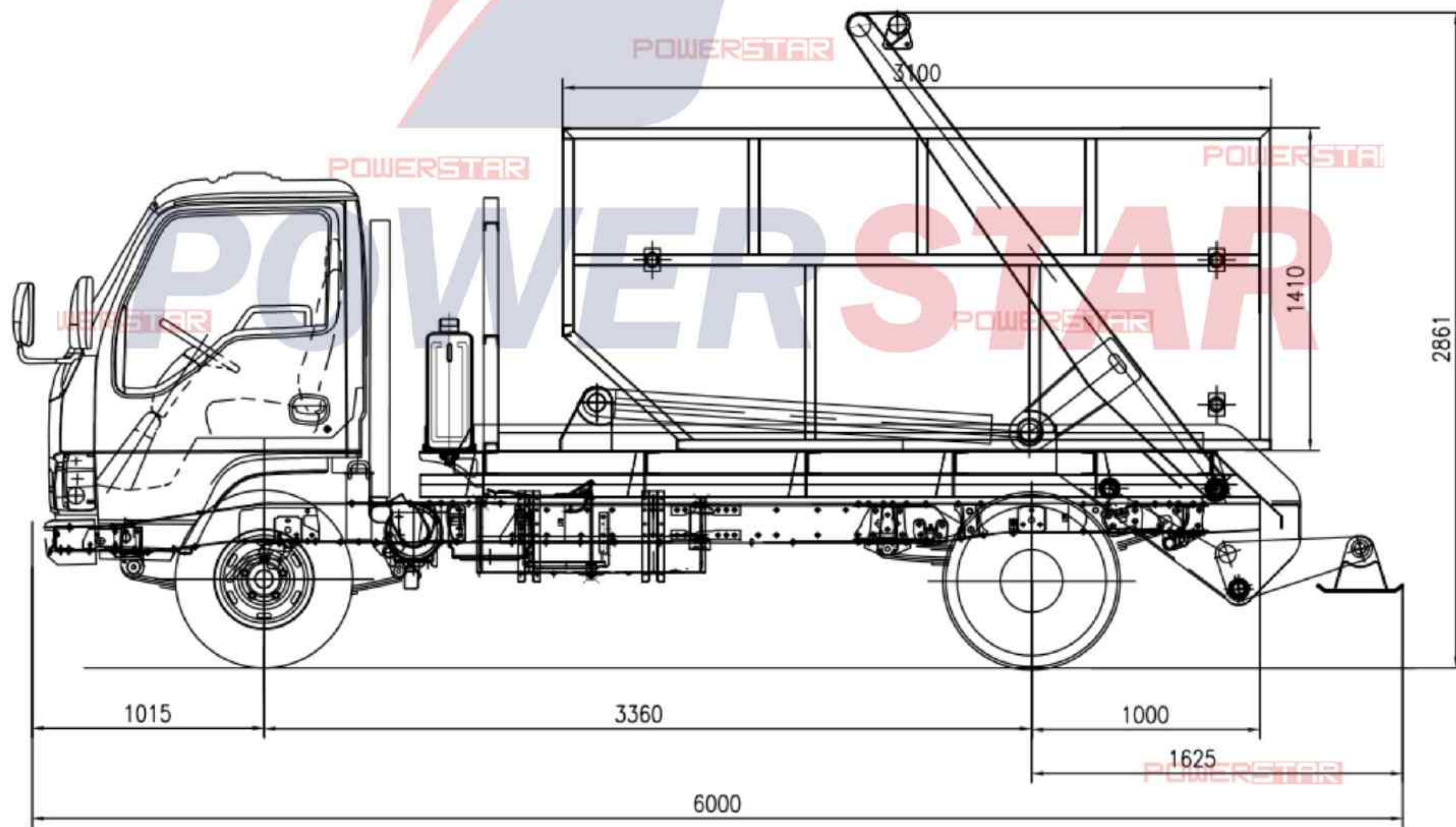

Hydraulic System: Swing arm hydraulic cylinder & Hydraulic cylinder



Garbage Container: Details please reference Chapter 3 part one



Hydraulic oil Tank: Located between truck cabin and super structure

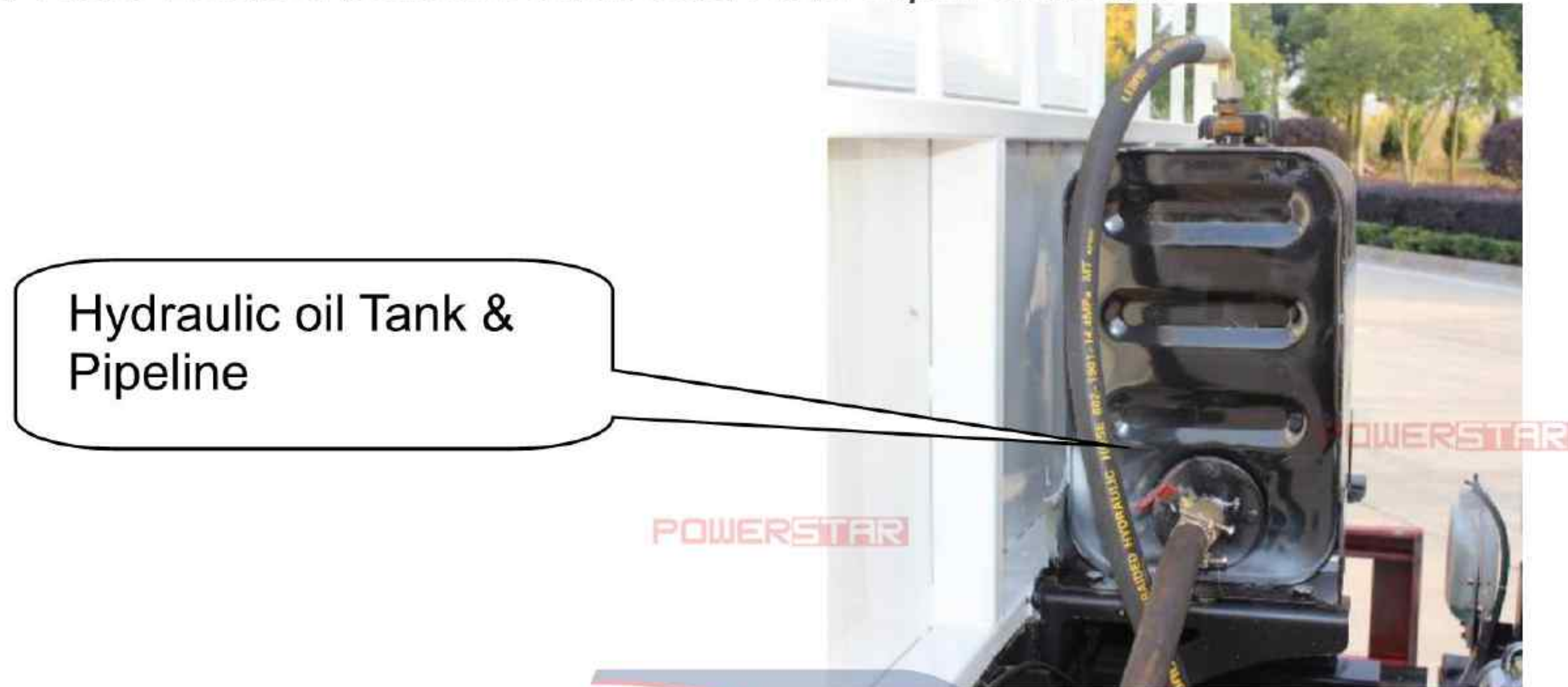

Hydraulic Control System: Multi-way control valve joysticks and pressure instrument panel

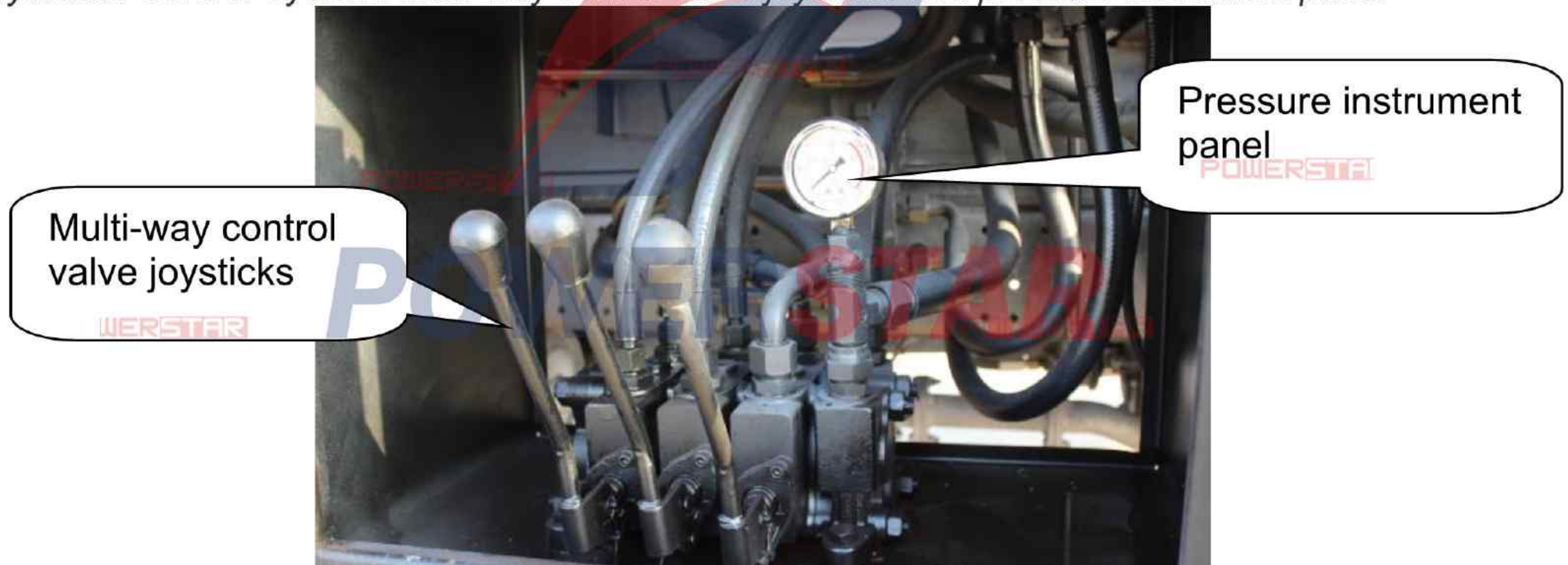

ii ,Skip Refuse Truck Operation Guidance **(Very Important)**

1. **The Preparation for Operation:** Carefully checking the operation environment, make sure no person stand around the truck, also do not forget pull the Parking Brake before any operation.
2. **PTO Operation:** Before operating the swing arm system, please make sure the PTO is working. Detail operation process should as follow, firstly start the truck engine and depress the clutch panel, secondly close the PTO switch, thirdly slowly loosen the clutch panel, then the oil pump start working.
3. **Hydraulic Legs Operation:** Operating multi-way control joysticks one & two to stretch hydraulic legs, only when the double hydraulic legs stabilized then can start other process.

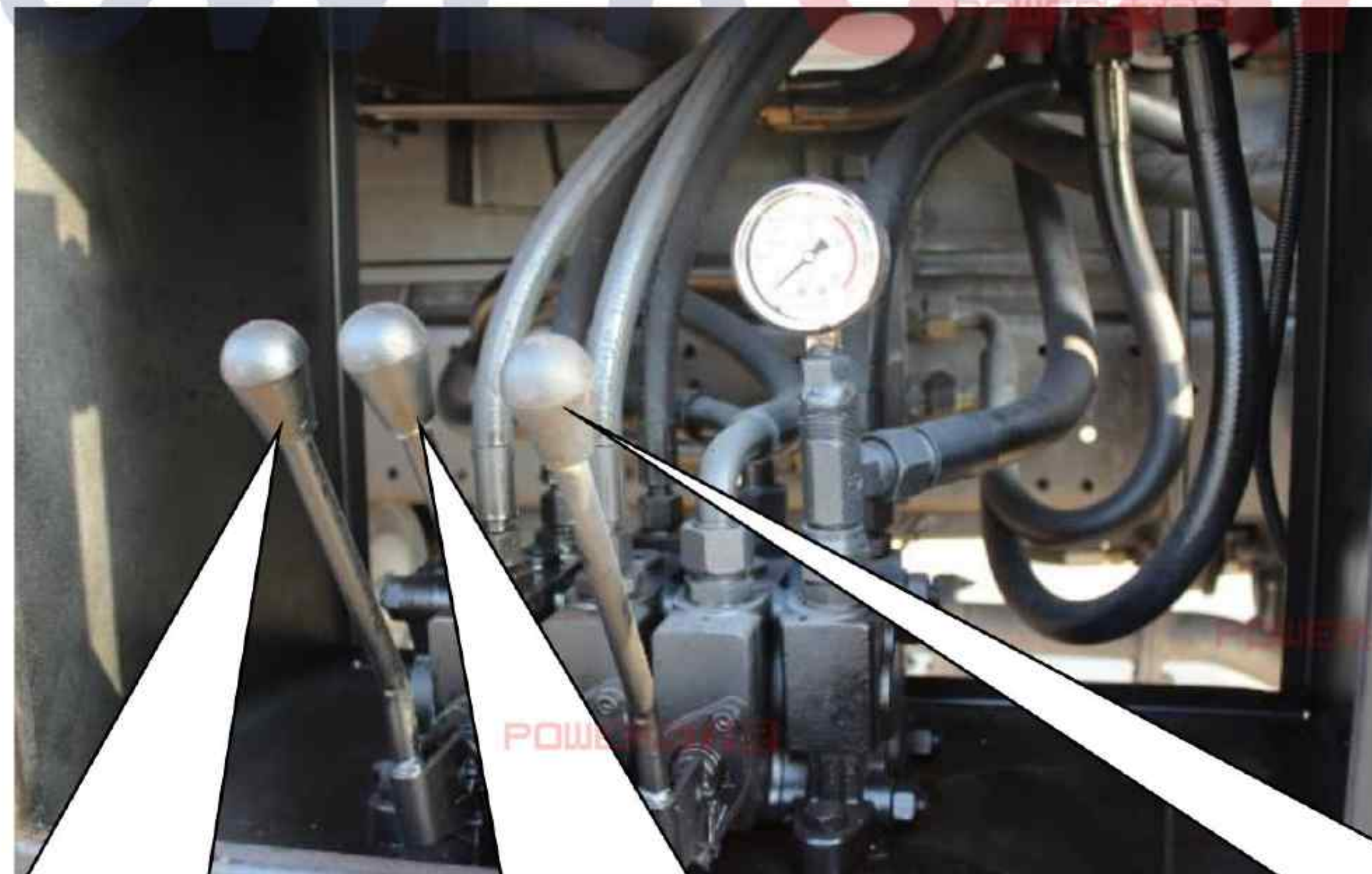

Joysticks one:
Control left side hydraulic leg

Joysticks two:
Control right side hydraulic leg

Joysticks three:
Control swing arm system

POWERSTAR



4. **Refuse Loading Operation:** Hang up the hinge chain connect with the container, operating the multi-way control joysticks three to loading and unloading the garbage container. Please note that the hinge chain is relaxation mode when container on the truck.

Joysticks One: Push → Left side hydraulic leg Stretch Out

Pull → Left side hydraulic leg Retract Back

Joysticks Two: Push → Right side hydraulic leg Stretch Out

Pull → Right side hydraulic leg Retract Back

Joysticks Three: Push → Swing arm rotating to load container

Pull → Swing arm rotating to unload container

5. **Garbage Transportation Operation:** Stop the oil pump and PTO, make sure the truck hydraulic system not working during transportation.

6. **Garbage Discharging Operation:** Following the above direction to unload garbage.

Chapter 5, Others for Attention

After carefully reading the above information, you must be well known how to use the ISUZU Skip Refuse Truck; below show some parts you need to pay attention while using the truck.

1. Please strictly follow the Operation Manual, and note that only skilled worker can be allowed operate the skip refuse truck.
2. Carefully checking the working environment, if the working place is slope with angle over 12%, you need to use block brake the wheel.
3. Keep nobody stand around when operating the skip refuse truck.
4. Before operating the swing arm system to load and unload the rubbish container, make sure the hydraulic legs are stretch out and stand stabilized.
5. Please do not adjust the hydraulic oil pressure, for which has been set in factory.
6. Please strictly follow the Owner's Manual to operate the skip refuse truck. If any unusual phenomenon happens during operation, you should stop the working immediately and carefully found out the reason, only when the troubleshooting then you can restart working.
7. The Hydraulic Oil should keep clean during working, if the oil become dirty, please kindly change the oil to make sure the truck can work smoothly.



Chapter 6 Troubleshooting

Please kindly checking below possible troubleshooting, which just for your reference.

Malfunction	Possible Reason	Solution
Oil Cylinder Piston Rod Oil leakage	<ol style="list-style-type: none"> 1. Sealing ring damage 2. Surface of the piston rod scratch 	<ol style="list-style-type: none"> 1. Carefully checking the sealing ring, change new one if necessary 2. Use sandpaper burnish it, change new one if necessary
Piston Rod Movement is Crawl or Peristalsis	<ol style="list-style-type: none"> 1. Hydraulic cylinder or hydraulic oil mixed with air 	<ol style="list-style-type: none"> 1. Eliminate air
The Hydraulic Cylinder Lifting Powerless	<ol style="list-style-type: none"> 1. Piston sealing element damage 2. System pressure too low (The safety valve imbalance) 3. System pressure too low (The internal leakage) 4. Oil pump damage 5. Hydraulic oil storage shortage 6. Oil filter blocked 	<ol style="list-style-type: none"> 1. Checking & replace the sealing element 2. Checking & adjust the safety valve pressure 3. Checking & replace the element 4. Checking & replace oil pump 5. Checking & refueling hydraulic oil 6. Checking & replace oil filter
Hydraulic legs Powerless	<ol style="list-style-type: none"> 1. Hydraulic lock leakage 2. Cylinder piston rod sealing element damage 	<ol style="list-style-type: none"> 1. Cleaning & replace the element 2. Checking & replace the sealing element
External Leakage	<ol style="list-style-type: none"> 1. Sealing ring damage 2. Oil pipeline surface damage 	<ol style="list-style-type: none"> 1. Checking & replace new sealing ring 2. Checking & replace new pipeline